



Veraview iX

- Accurate LED Positioning Guide
- High Frequency DC Generator Reduces Patient Dosage
- Optimized Time Settings for Film and Digital Exposures
- Simplified Operation with Illuminated Pictogram Menu
- Easy Seat Height Adjustment

Thinking ahead. Focused on life.

LED Positioning Guide Eliminates Guesswork for Accurate Alignment



LED Positioning Guide

- Two LED light beams converge into a single point for visual confirmation of correct alignment for accurate x-rays.
- The cone is short and easy to manipulate which also facilitates correct positioning. It is also transparent for superior visibility.
- The lightweight head and arm can easily be maneuvered with a delicate touch.

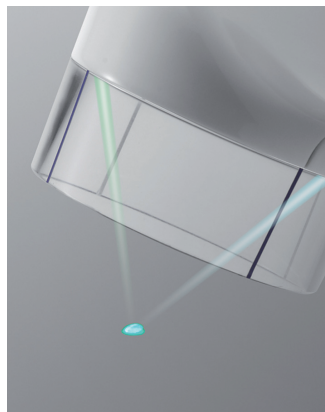

Constant Voltage DC Generator

- By utilizing a high frequency, direct current (DC) generator, this unit produces 'hard' x-rays which offer reduced dosage compared to units that operate with an alternating current.
- Tube voltage can be set at 60 kV or 70 kV.

Exposure Settings

- Digital or film scan options are available. An optimized exposure time is set after parameter selections are made.

Illuminated Pictogram Menu

- Menu items illuminate to confirm selections and help prevent mistakes.

Easy Seat Height Adjustment

- Seat height is easily adjusted by pulling up the lever for the gas cylinder under the seat.

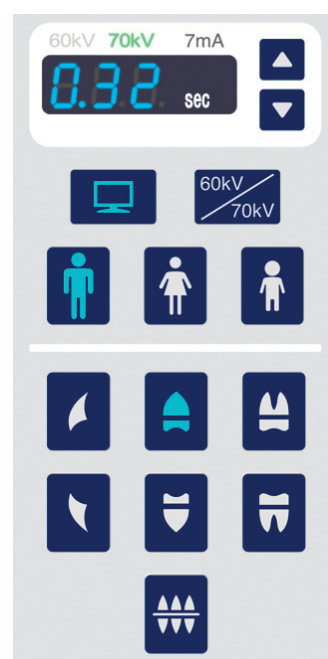

Dimensions

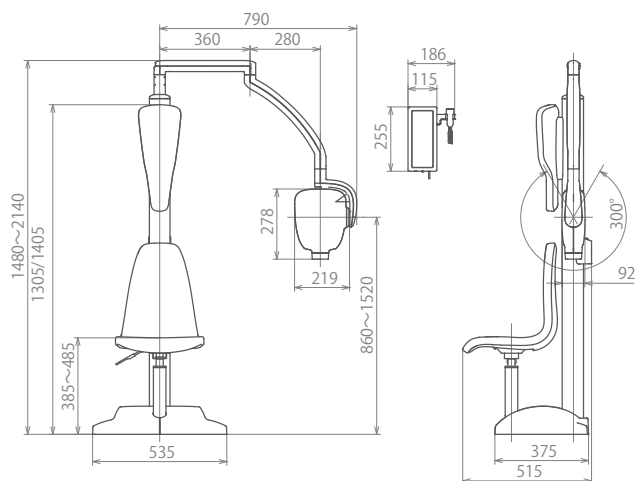

Specifications

Model	Veriview iX
Voltage	100-120 / 220-240 VAC
Power Consumption	1.9 kVA
Tube Potential	60 / 70 kV
Tube Current	7 mA
Exposure Time	0.01~2 seconds
Weight	approx. 25 kg

Developed and Manufactured by

J. MORITA MFG. CORP.

680 Higashihama Minami-cho, Fushimi-ku, Kyoto, 612-8533 Japan

Tel: +81-6-6380-1521, Fax: +81-6-6380-0585, <http://www.jmorita-mfg.com>

MORITA GLOBAL WEBSITE

URL <http://www.morita.com>

J. MORITA CORPORATION

33-18, 3-Chome, Tarumi-cho Suita City, Osaka, 564-8650 Japan

Tel: +81-6-6380-1521, Fax: +81-6-6380-0585

J. MORITA USA, INC.

9 Mason Irvine, CA 92618 U.S.A.

Tel: +1-949-581-9600, Fax: +1-949-465-1095

J. MORITA EUROPE GMBH

Justus-von-Liebig-Strasse 27A, D-63128 Dietzenbach, Germany

Tel: +49-6074-836-0, Fax: +49-6074-836-299

SIAMDENT CO., LTD.

444 Olympia Thai Tower, 3rd Floor, Ratchadapisek Road, Samsenok, Huay Kwang, Bangkok 10310, Thailand

Tel: +66-2-512-6049, Fax: +66-2-512-6099, <http://www.siamdent.com>

J.MORITA CORPORATION AUSTRALIA & NEW ZEALAND

Suite 2.05, 247 Coward Street, Mascot, NSW 2020, Australia

Tel: +61-2-9667-3555, Fax: +61-2-9667-3577

J.MORITA MIDDLE EAST

4 Tag Al Aoasaa, Saba Pacha 21311, Alexandria, Egypt

Tel: +203-58-222-94, Fax: +203-58-222-96